

1.0/2.3 Straight Crimp Plug For RA8000 (75 Ohm)

Part number: 301-126

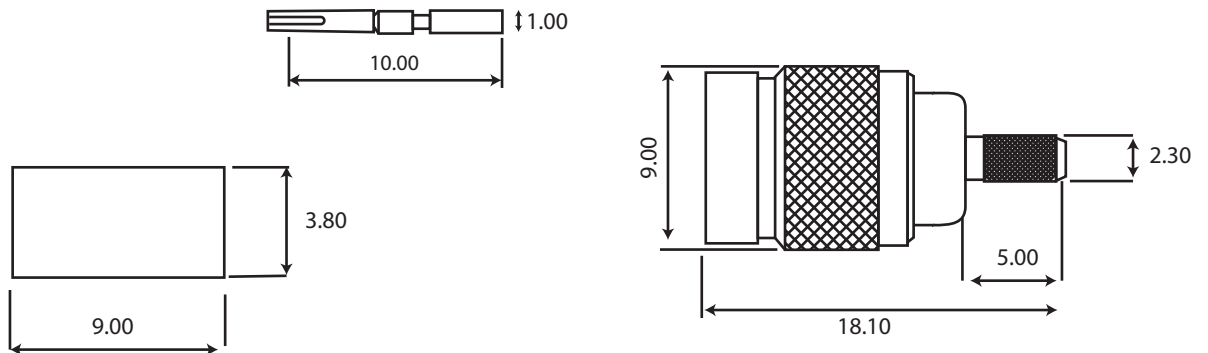

Gender	Plug
Orientation	Straight
Insulator Material	PTFE
Body Material	Brass
Body Finish	Nickel
Contact Material	Beryllium Copper
Contact Finish	Gold
Termination Style	Cable - Crimp
Crimp Tool	B
Impedance	75 Ohm
Contact Termination	Solder
Coupling Mechanism	Push-Pull
Polarity	Standard
Max Freq (Ghz)	10.0
Ext Dielectric	No
Isolated	No
Low PIM	No
RoHS Compliant	Yes
REACH Compliant	Yes