

BNC Panel Solder Socket For Brass Body Delrin Dielectric(Short Barrel)(75Ohm)

Part number: 305-504

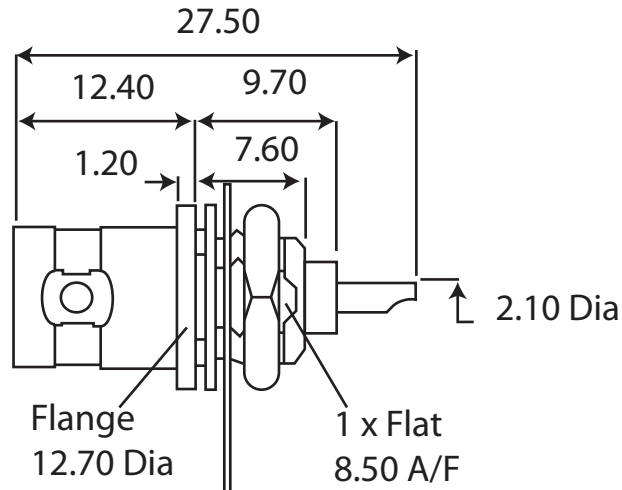

Description	BNC Panel Jack, Solder Receptacle
Fixing Method	Panel
Body	Brass, Nickel Plated
Contact	Phosphor Bronze, Gold Plated
Dielectric	Delrin
Locknut	Brass, Nickel Plated
Solder Tag	SS41, Nickel Plated
Washer	SS41, Nickel Plated
Durability	500 mating cycles
Impedance	75 ohms
Max. Frequency	4 GHz
Temperature Range	-55 to +85 degrees C
Working Voltage	500 Volts RMS Maximum