

REV	MCO	DWN	DATE
A	20019792	TH	12/28/98
B	20236325	RCR	25-MAR-08

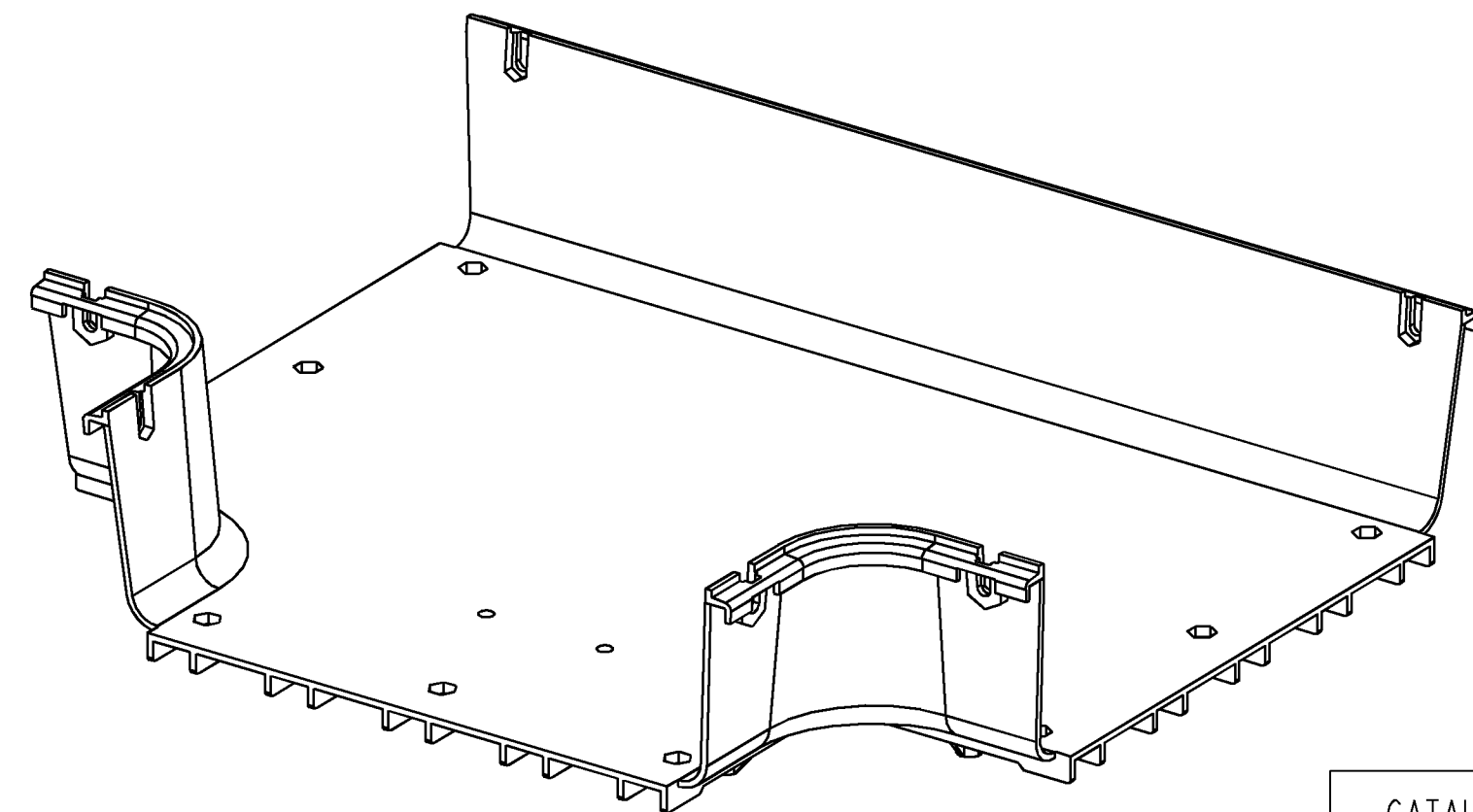
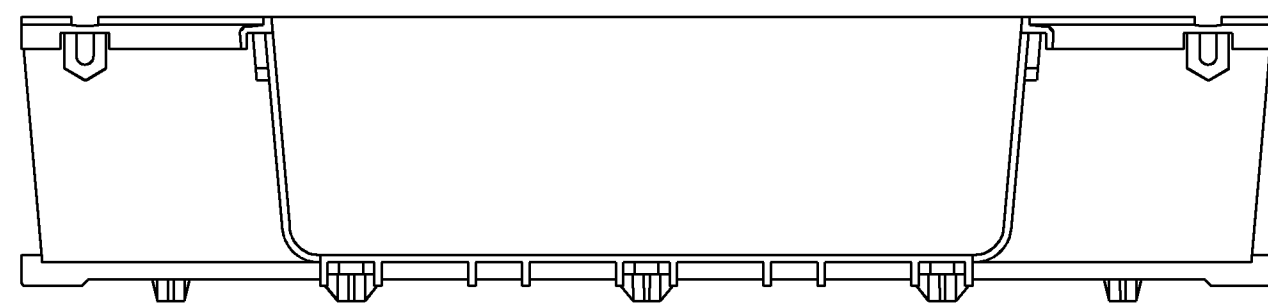
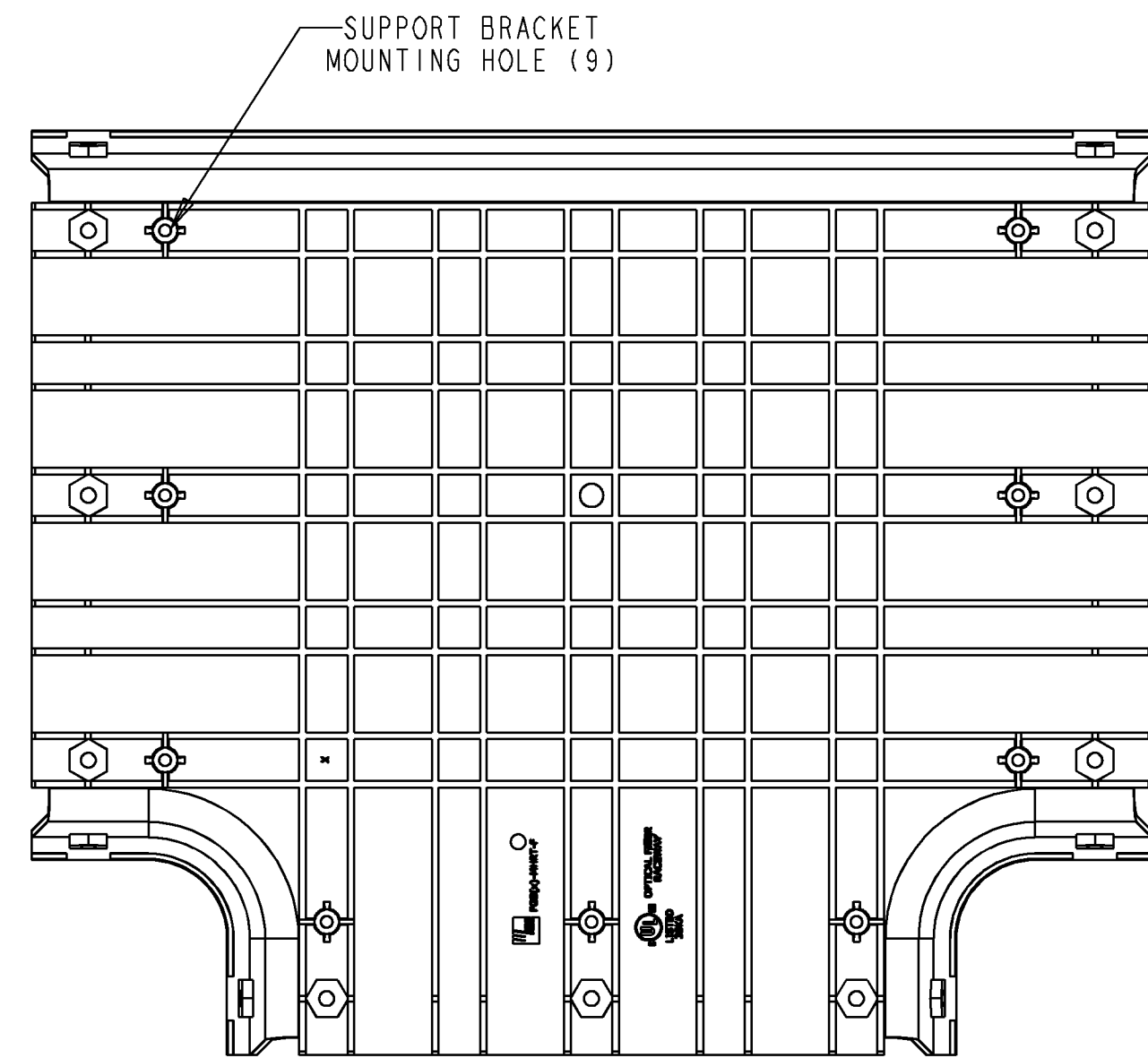
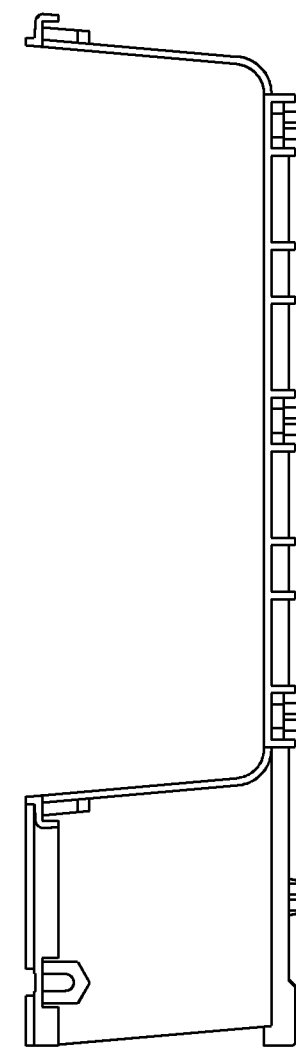
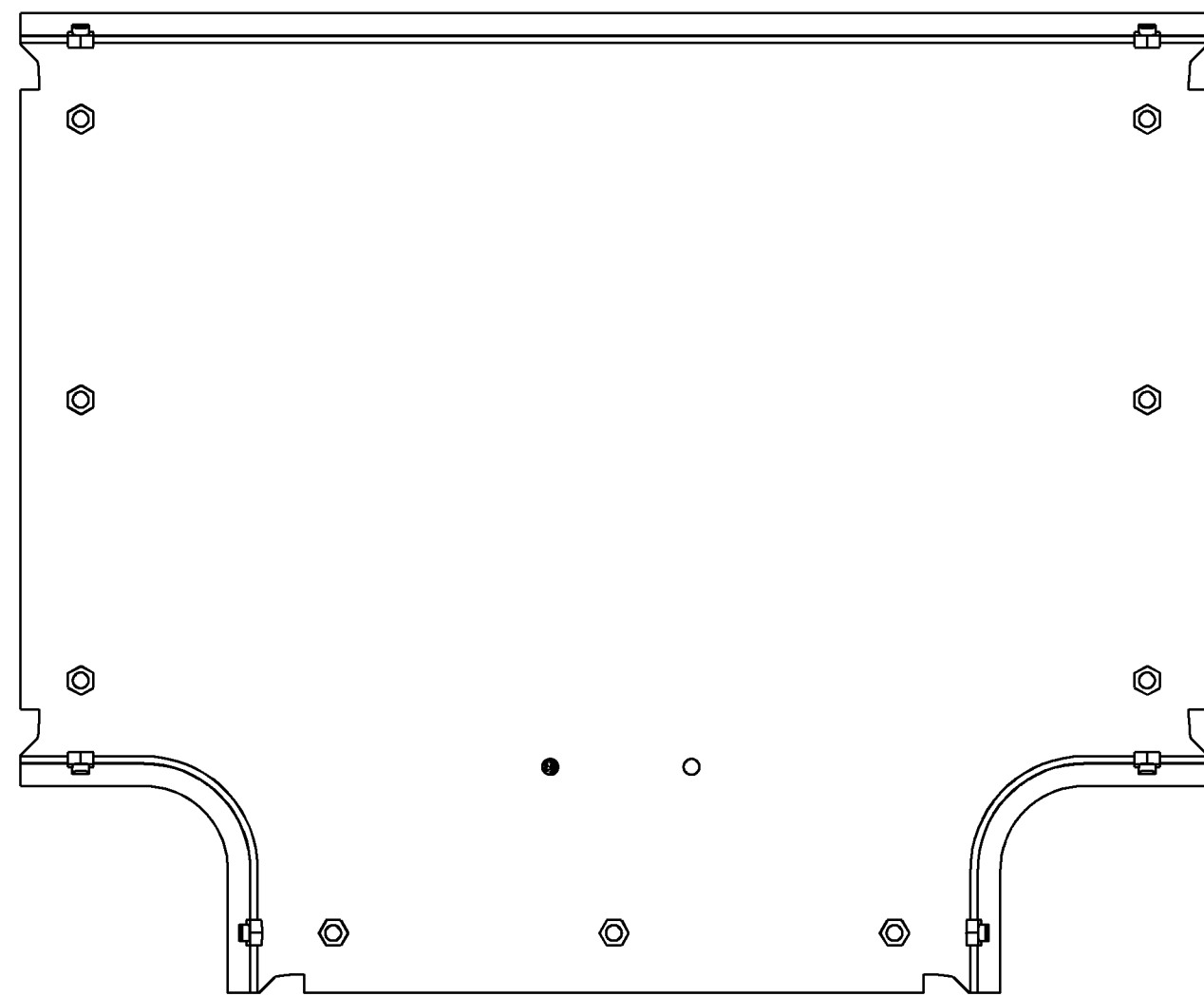

SCALE 0.310

CATALOG NO.	COLOR
FGS-MHRT-F	YELLOW
FGSO-MHRT-F	ORANGE
FGSB-MHRT-F	BLACK

NOTES:

1. MATERIAL IS SELF EXTINGUISHING WITH A UL 94 RATING OF V-0.



INFORMATION ON THIS DOCUMENT IS PROPRIETARY TO ADC AND SHALL NOT BE USED, COPIED, REPRODUCED OR DISCLOSED IN WHOLE OR IN PART WITHOUT WRITTEN CONSENT OF ADC.

ALL DIMS AND TOLERANCES ARE INCHES UNLESS OTHERWISE SPECIFIED

.XX:±.01	SIZE
.XXX:±.005	
ANGULAR:±1°	

TITLE TEE, HORIZ, 4X12 INSTALLATION DWG

DO NOT SCALE DRAWING

ENGR: T. HAATAJA  
DWN: T. HAATAJA

DRAWING NUMBER 1044464

SHT. 1 OF 1

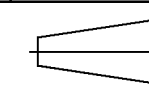
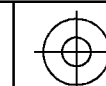

DIMENSIONS IN INCHES  
THIRD ANGLE PROJECTION